

Digital Logic

Appendix A

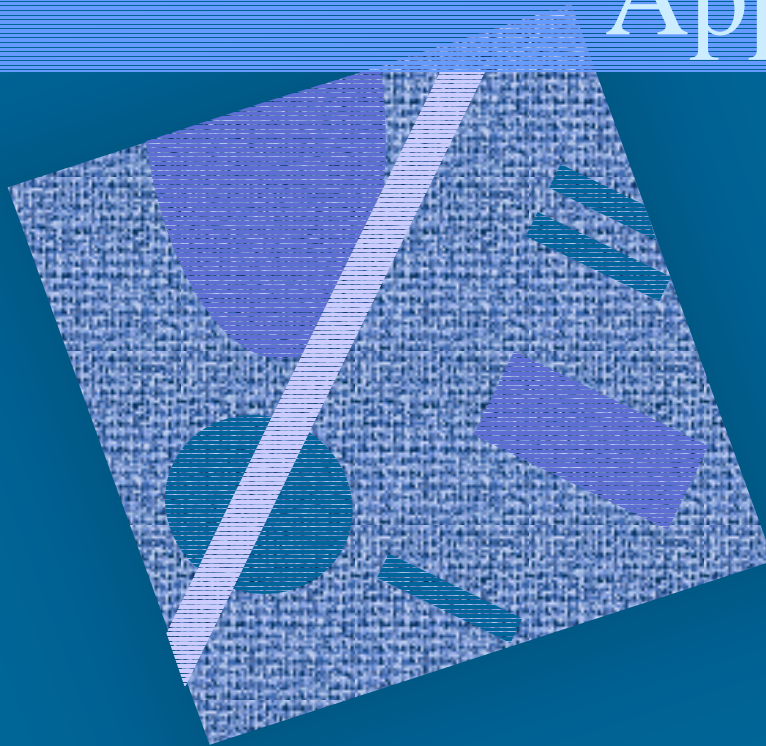

Boolean Algebra
Gates
Combinatorial Circuits
Sequential Circuits

Boolean Algebra

- George Boole
 - ideas 1854
- Claude Shannon,
 - apply to circuit design, 1938 (piirisuunnittelu)
- Describe digital circuitry function
 - programming language?
- Optimise given circuitry
 - use algebra (Boolean algebra) to manipulate (Boolean) expressions into simpler expressions

Boolean Algebra

- Variables: A, B, C
- Values: TRUE (1), FALSE (0)
- Basic logical operations:
 - binary: AND (\bullet), OR (+) $A \bullet B = AB$ $B + C$
 - unary: NOT ($\bar{\quad}$) \bar{A} (ja, tai, ei)
- Composite operations, equations
 - precedence: NOT, AND, OR
 - parenthesis $D = A + \bar{B} \bullet C = A + ((\bar{B})C)$

Boolean Algebra

- Other operations

- NAND

$$A \text{ NAND } B = \text{NOT } (A \text{ AND } B) = \overline{AB}$$

- NOR

$$A \text{ NOR } B = \text{NOT } (A \text{ OR } B) = \overline{A + B}$$

- Truth tables

- What is the result of the operation?

		Q	
	AND	0	1
P	0	0	0
	1	0	1

Table A.1

P	Q	P AND Q
0	0	0
0	1	0
1	0	0
1	1	1

Postulates, Identities in Boolean Algebra

- How can I manipulate expressions?
 - Simple set of rules?
- Basic identities
 - commutative laws
 - distributive laws
 - identity elements
 - inverse elements
 - associative laws
 - DeMorgan's theorem

Table A.2

(vaihdantalait)

(osittelulait)

(identiteetit)

(vasta-alkiot)

(liitöntälait)

(DeMorganin laki)

Gates

(portit)

- Fundamental building blocks

- easy to build

<http://tech-www.informatik.uni-hamburg.de/applets/cmos/cmosdemo.html>

- implement basic Boolean algebra operations

- Combine to build more complex circuits

- memory, adder, multiplier

(yhteenlaskupiiri,
kertolaskupiiri)

- 1-3 inputs, 1 output

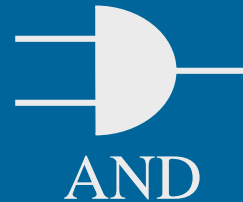

Fig. A.1

- Gate delay

(viive)

- change inputs, new output available after gate delay

1 ns? 10 ns?

Functionally Complete Set

- Can build all basic gates (“and”, “or”, “not”) from a smaller set of gates
 - With “and”, “or”, “not” (trivial!)
 - With “and”, “not”

- “or”?

$$A + B = \overline{\overline{A} \bullet \overline{B}}$$

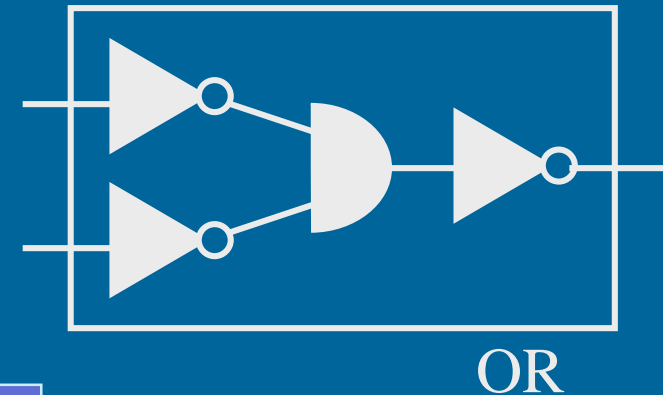

- With “or”, “not”
 - With “nand” alone Fig A.2
 - With “nor” Fig A.3

Combinational Circuits ⁽³⁾ (yhdistelmäpiirit)

- Interconnected set of gates
 - change input, wait for gate delays, new output
- Output is Boolean function of input signals
 - m (binary, Boolean) inputs
 - n (binary, Boolean) outputs
- Described in three ways
 - describe function with Boolean equations (one for each output)
$$F = \overline{A}B\overline{C} + \overline{A}BC + A\overline{B}\overline{C}$$
 - describe function with truth table Table A.3
 - describe implementation with graphical symbols for gates and wires Fig A.4

Simplify Presentation (and Implementation) (3)

- Boolean equations
 - Sum of products form (SOP)

$$F = \overline{A}B\overline{C} + \overline{A}BC + A\overline{B}\overline{C}$$

Fig A.4

- Product of sums form (POS)

$$F = (A + B + C) \cdot (A + B + \overline{C}) \cdot (\overline{A} + B + C) \cdot (\overline{A} + B + \overline{C}) \cdot (\overline{A} + \overline{B} + \overline{C})$$

Boolean algebra

Fig A.5

Which presentation is better?
Fewer gates? Smaller area on chip?
Smaller circuit delay? Faster?

Algebraic Simplification

- Circuits become too large to handle?
- Use basic identities to simplify Boolean expressions

$$\begin{aligned} F &= \overline{A}B\overline{C} + \overline{A}BC + A\overline{B}\overline{C} \\ &= \overline{A}B + B\overline{C} = B(\overline{A} + \overline{C}) \end{aligned}$$

Fig A.5

Fig A.6

- May be difficult to do
- How to do it automatically?
- Build a program to do it “best”?

$$\begin{aligned} f &= \overline{a}b\overline{c}d + \overline{a}bcd + a\overline{b}\overline{c}d + a\overline{b}cd \\ &\quad + ab\overline{c}d + abc\overline{d} + abc\overline{d} + ab\overline{c}d \end{aligned}$$

Karnaugh Map Squares

- Each square represents complete input value combination
 - canonical form: each term has each variable once
 - adjacent squares differ only in one input value (wrap around)

order!!

CD: 00	01	11	10	
<u>AB</u>				
00	0000	0001	0011	0010
01	0100	0101	0111	0110
11	1100	1101	1111	1110
10	1000	1001	1011	1010

Square for input value combination

$$\overline{A}\overline{B}CD = 1001$$

Karnaugh Maps

- Represent Boolean function (I.e., circuit) truth table in another way

Fig A.7

- each square is **one product** in sums-of-products (SOP) presentation
- value is one (1) iff corresponding input values give value 1, o/w value is “empty”
- value is 1 if function value for those input values is one

CD

	00	01	11	10
00			1	
01				
11	1			
10		1		

AB

$$F = \overline{A}BCD + ABC\overline{D} + A\overline{B}C\overline{D}$$

Karnaugh Map Simplification

- Starting point:
 - Adjacent squares differ only in one input variable value

1	1
c	\bar{c}

Adjacent squares have value 1



Input values differ only in one variable



Value of that variable is irrelevant
(when all other input variables are fixed
to corresponding values for those squares)



Can ignore that variable for those expressions

Using Karnaugh Maps to Minimize Boolean Functions ⁽⁶⁾

Original function

$$f = \overline{a}\overline{b}cd + \overline{a}b\overline{c}d + a\overline{b}\overline{c}d + a\overline{b}c\overline{d} + abcd + abc\overline{d} + a\overline{b}c\overline{d} + a\overline{b}c\overline{d}$$

Canonical form (now already there)

Karnaugh Map

Find smallest number of circles, each with largest number of 1's

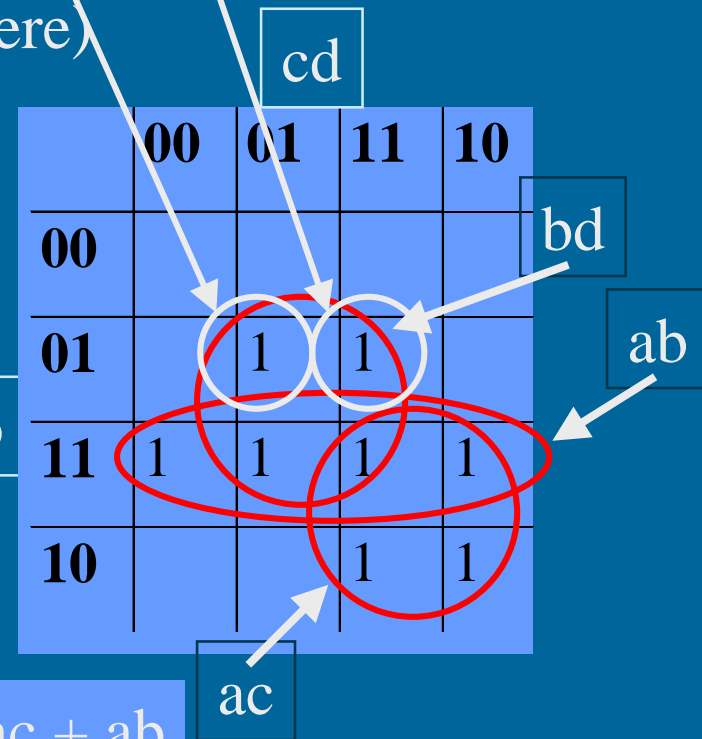

Select parameter combinations corresponding to the circles

Get reduced function $f = bd + ac + ab$

Impossible Input Variable Combinations

- What if some input combinations can never occur?
 - Mark them “don’t care” or “d”
 - treat them as 0 or 1, whichever is best
 - more room to optimize

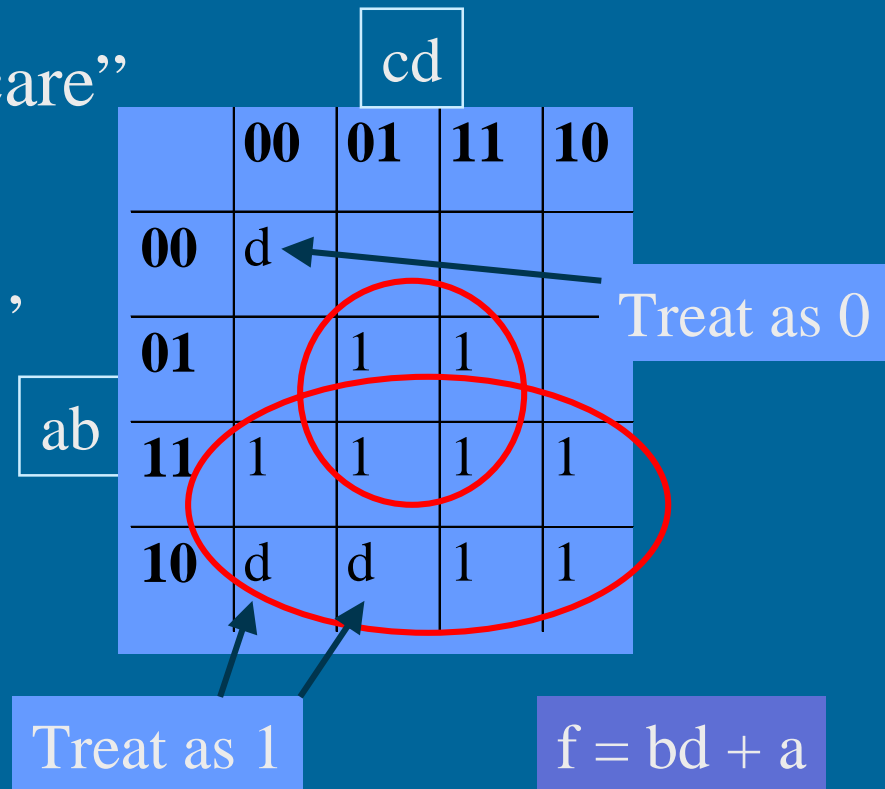

Example: Circuit to add 1 (mod 10) to 4-bit BCD decimal number ⁽⁴⁾

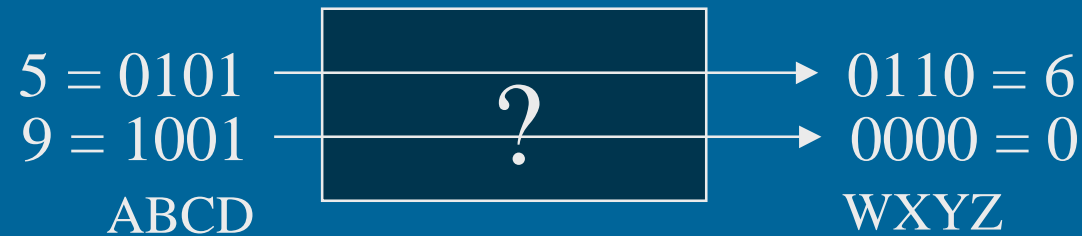

Truth table?

Table A.4

Karnaugh maps for W, X, Y and Z?

Fig. A.10

Quine-McKluskey Method

- Another method to minimise Boolean expressions
- Why?
 - Karnaugh maps become complex with 6 input variables
- Quine-McKluskey method
 - tabular method
 - automatically suitable for programming
 - details skipped

Basic Combinational Circuits

- Building blocks for more complex circuits
 - Multiplexer
 - Encoders/decoder
 - Read-Only-Memory
 - Adder

Multiplexers ⁽²⁾

- Select one of many possible inputs to output
 - black box Fig A.12
 - simple truth table Tbl A.7
 - implementation Fig A.13
- Each input/output “line” can be many parallel lines
 - select one of three 16 bit values Fig A.14
 - $C_{0..15}$, $IR_{0..15}$, $ALU_{0..15}$
 - simple extension to one line selection
 - lots of wires, plenty of gates ...

Encoders/Decoders

- Only one of many Encoder input or Decoder output lines can be 1
- Encode the line number as output
 - hopefully less pins (wires) needed this way
 - optimise for space, not time
 - Example:
 - encode 8 input wires with 3 output pins
 - route 3 wires around the board
 - decode 3 wires back to 8 wires at target

Fig A.15



Read-Only-Memory (ROM) ⁽⁴⁾

- Given input values, get output value
 - Like multiplexer, but with fixed data
- Consider input as address, output as contents of memory location
- Truth tables for a ROM

Table A.8

Mem (7) = 4

Mem (11) = 14

- Implementation with decoder & or gates

Adders (4)

1-bit adder



1-bit adder with carry

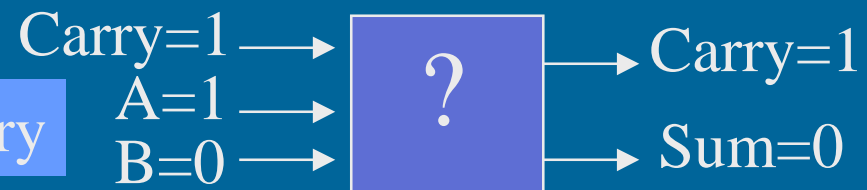

Implementation

Table A.9, Fig A.22

Build 4-bit adder from 4 1-bit adders

Fig A.21

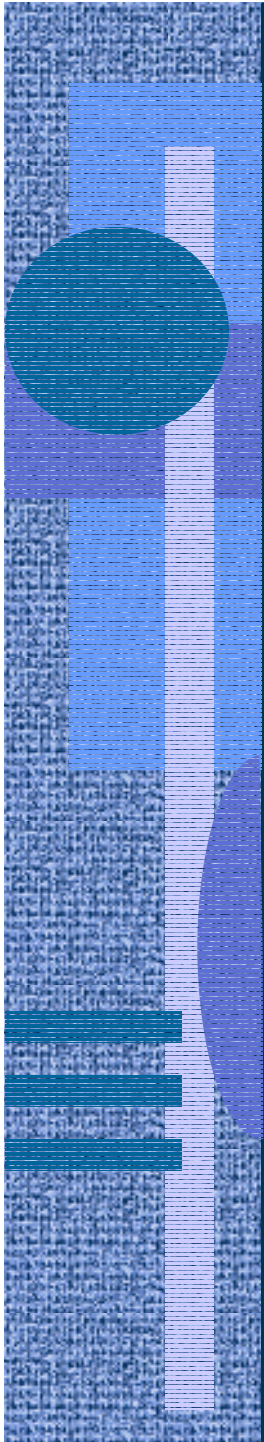

6.9.2002

Copyright Teemu Kerola 2002

23

Sequential Circuit

(sarjalliset piirit)

- Circuit has (modifiable) internal state
- Output of circuit depends (also) on internal state
 - not only from current inputs
 - $\text{output} = f(\text{input}, \text{state})$
 - $\text{new state} = f(\text{input}, \text{state})$
- Processor control, registers, memory

Flip-Flop

(kiikku)

- 2 states for Q (0 or 1, true or false)
- 2 outputs Q and \bar{Q}
 - complement values
 - both always available on different pins
- Need to be able to change the state (Q)

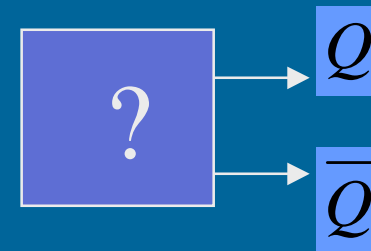

S-R Flip-Flop or S-R Latch (4)

(laituri)

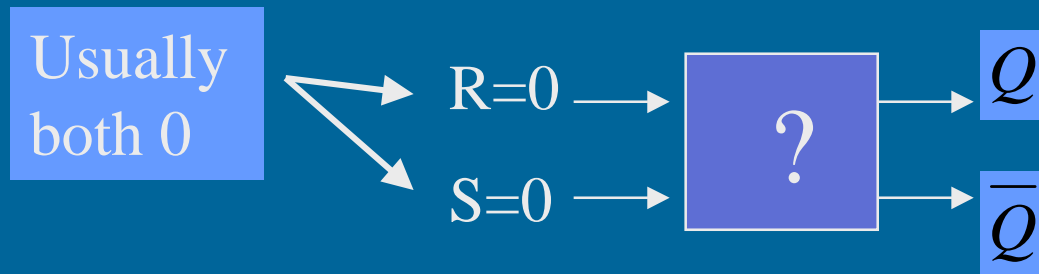

“Write 1” = “set S=1 for a short time” = “set” 1
0

“Write 0” = “set R=1 for a short time” = “reset”

nor (0, 0) = 1
 nor (0, 1) = 0
 nor (1, 0) = 0
 nor (1, 1) = 0

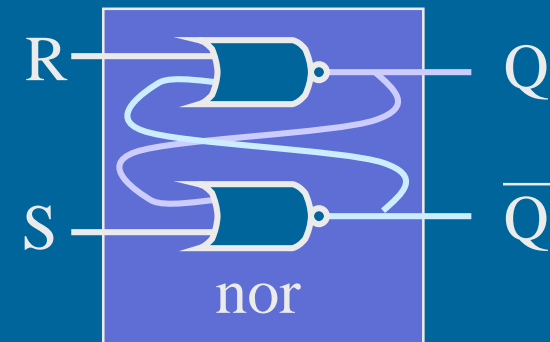

S-R Latch Stable States (3)

- 1 bit memory (value = value of Q)
- bi-stable, when R=S=0
 - Q=0?
 - Q=1?

nor (0, 0) = 1
nor (0, 1) = 0
nor (1, 0) = 0
nor (1, 1) = 0

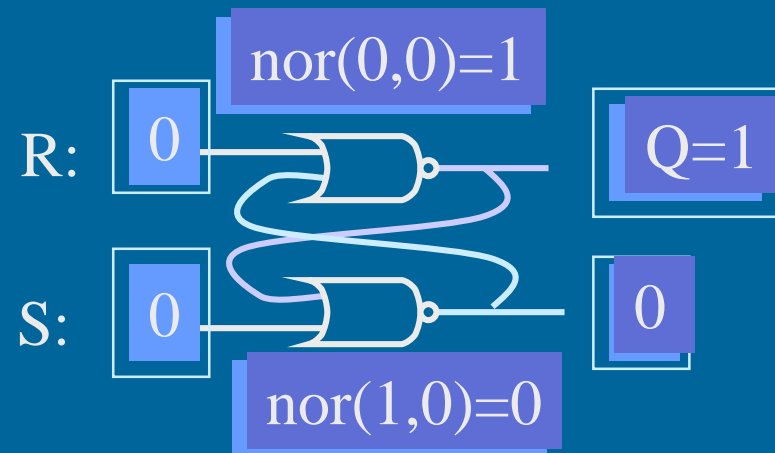

S-R Latch Set (1) and Reset (0) ⁽ⁿ⁾

Write 1: $S=0 \rightarrow 1 \rightarrow 0$

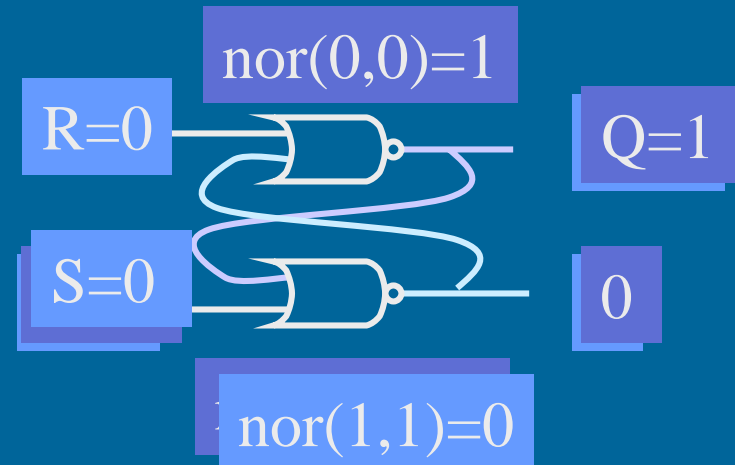

Write 0: $R=0 \rightarrow 1 \rightarrow 0$

nor (0, 0) = 1
nor (0, 1) = 0
nor (1, 0) = 0
nor (1, 1) = 0

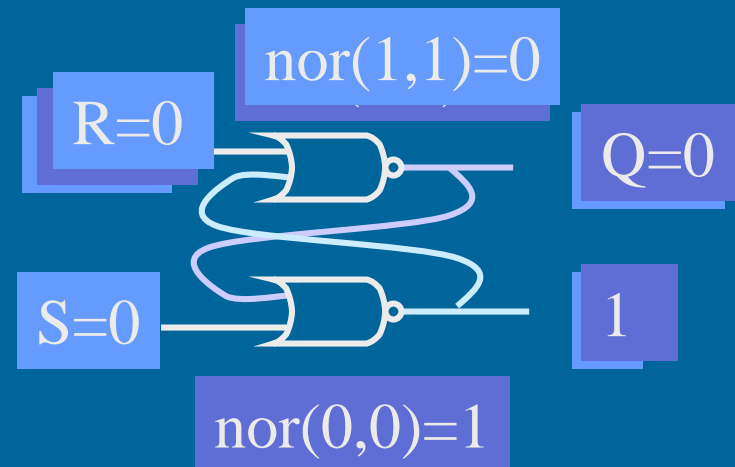

Clocked Flip-Flops

- State change can happen only when clock is 1
 - more control on state changes
- Clocked S-R Flip-Flop Fig. A.26
- D Flip-Flop Fig. A.27
 - only one input D
 - $D = 1$ and CLOCK \rightarrow write 1
 - $D = 0$ and CLOCK \rightarrow write 0
- J-K Flip-Flop Fig. A.28
 - Toggle Q when $J=K=1$ Fig. A.29

Registers (2)

- Parallel registers
 - read/write
 - CPU user registers
 - additional internal registers
- Shift Registers
 - shifts data 1 bit to the right
 - serial to parallel?
 - ALU operation?
 - rotate?

Fig. A.30

Fig. A.31

Counters (4)

- Add 1 to stored counter value
- Counter
 - parallel register plus increment circuits
- Ripple counter
 - asynchronous
 - increment least significant bit, and handle “carry” bit as far as needed
- Synchronous counter
 - modify all counter flip-flops simultaneously
 - faster, more complex, more expensive

Summary

- Boolean Algebra \rightarrow Gates \rightarrow Circuits
 - can implement all with NANDs or NORs
 - simplify circuits: Karnaugh, Quine-McKluskey
- Components for CPU design
 - ROM, adder
 - multiplexer, encoder/decoder
 - flip-flop, register, shift register, counter

-- End of Appendix A: Digital Logic --

Simple processor

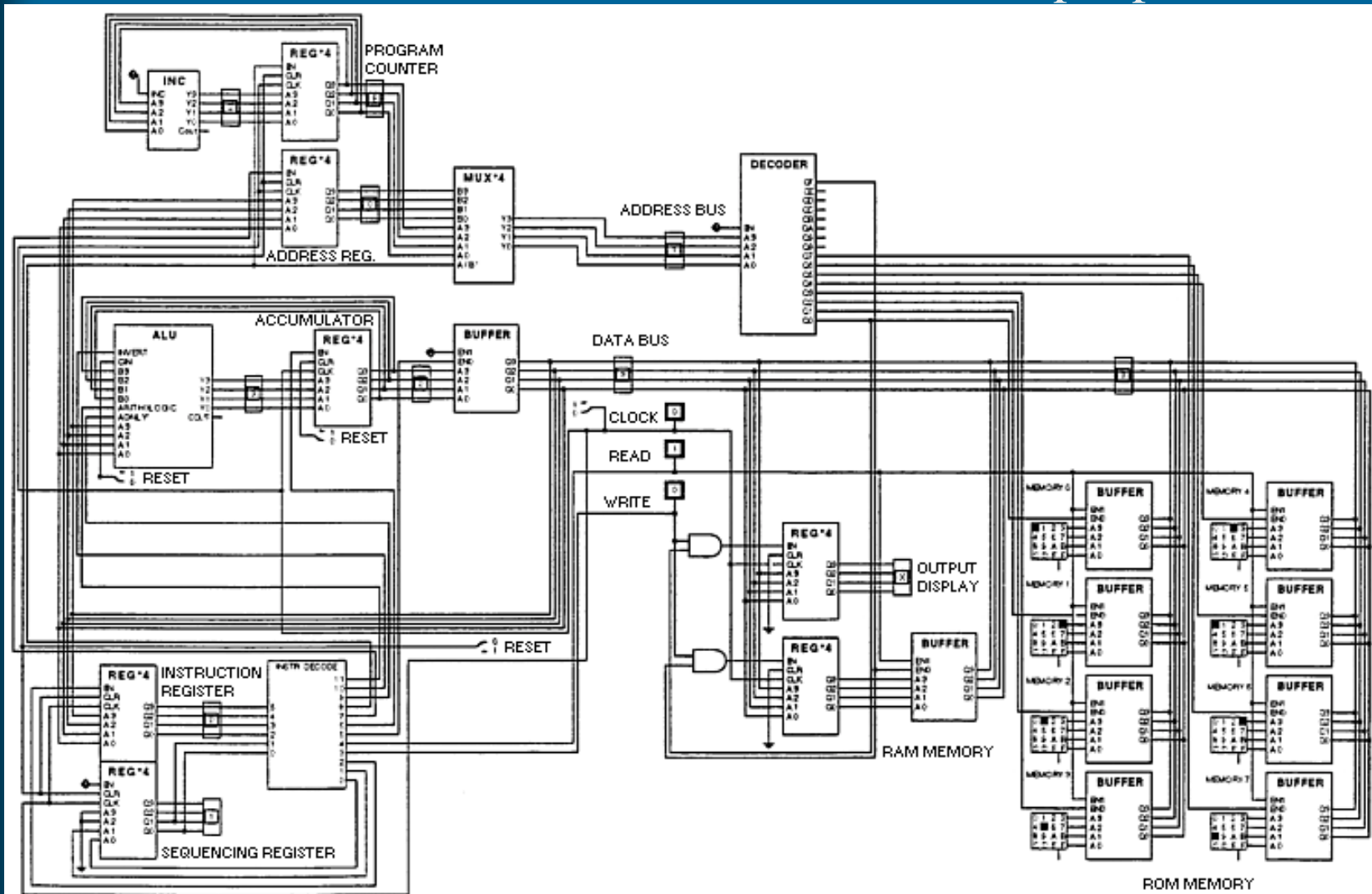

http://www.gamezero.com/team-0/articles/math_magic/micro/stage4.html